

Produktový list

Objednací kód: **AL3915CAL6015C**

ALTIS LINE obdélníkový sprchový kout 1100x900 mm, L/P varianta

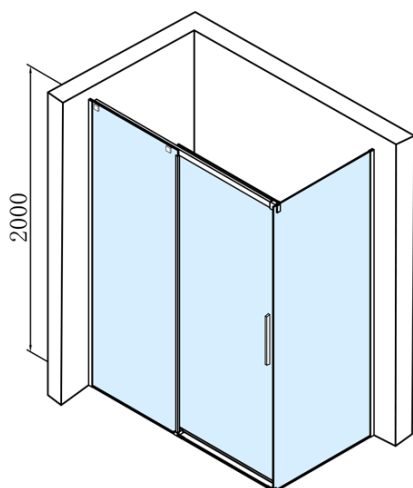

MODEL	A	B	C
AL3915C	1082-1122	498	425
AL3015C	1182-1222	548	475
AL4015C	1282-1322	598	525
AL4115C	1382-1422	648	575
AL4215C	1482-1522	698	625
AL4315C	1582-1622	748	675

MODEL	D
AL5915C	780-800
AL6015C	880-900
AL6115C	980-1000

